

Article number: 3918044010222

Description: Worm gear with st. steel hollow shaft
VF 44 EP-A-10- 63B5

Measures

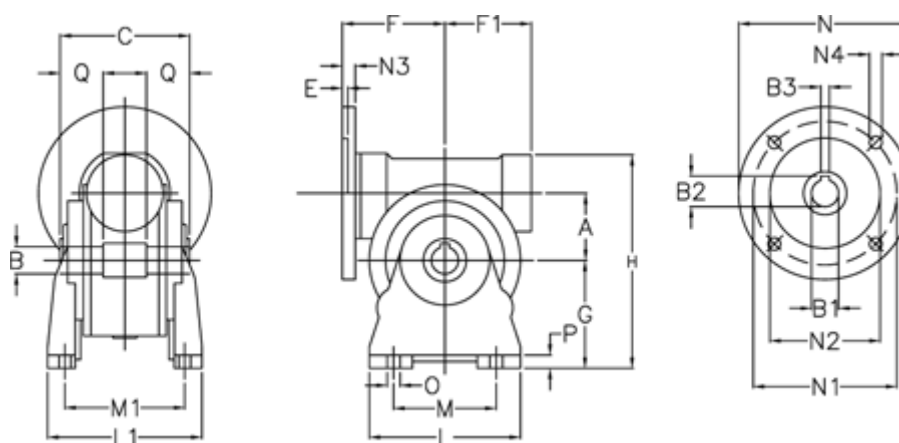

a	= 44.6	F1	= 54	N1	= 115
B	= 18	g	= 72	N2	= 95
B1 E7	= 11	H	= 143	N3	= 10.5
B2	= 12.8	L	= 90	N4	= 9.5
B3 H9	= 4	L1	= 98.0	O	= 8.5
C	= 64	m	= 52	P	= 10
E	= 2.0	M1	= 81.0	Q	= 24.5
F	= 65	N	= 140		